



PREHUNG DOOR

PACKAGING AND PROTECTION PRODUCTS





For more than 30 years, Penrod has been a leader in the hardware industry, backed by more than a century of serving customers with a guarantee of quality and assurance.

Penrod offers a wide range of high quality, reliable, and trusted products in a variety of hardware categories to our customers serving the residential door market. Whether it's hinges, door hardware, barn door hardware, or products that help our customers protect their finished goods throughout delivery; Penrod prides itself on being a one-stop shop for our customers that is built on a commitment of integrity and on-time delivery, all at a competitive price.

Lift Handle



Scan for video

Lift Handle with Preloaded Screws Part #M27576 • with screws

This pre-loaded lift handle offers time-saving installation and inventorying advantages, as well as cost savings. With six pre-loaded screws, each handle offers installers an easier and safer application, saves over a minute per handle when compared to manual installation, and has an innovative 300-pound load test.

Hinge Protection

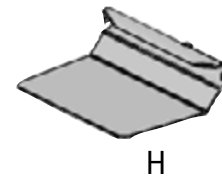

Scan for video

OSHA Hinge Protector Not stocking • call for info

THE OSHA Hinge Protector is a 4 - inch cover for use on interior and exterior doors, right and left handed swing. Provides protections to the hinge and adjacent door. More effective than cardboard or rubber bands. Keeps hands protected from screws protruding the jamb.

Door Protection Part #M27582 • single hinge protector, flush

Our hinge protector is not a normal slid on hinge protector. We designed our hinge protector with a top and bottom clip to keep it from falling off. By adding the tabs to the protector, you will minimize damage to the adjacent doors and prevent slip hazards in your warehouse and door shops.

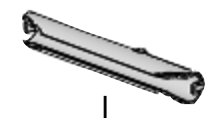

Scan for video

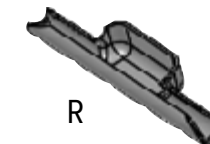

Scan for video

Hinge Protector with Spacer Not stocking • call for info

This clip on hinge protector has the same features as our normal hinge protectors, but is raised for a point of contact. This will give more protection to the adjacent door during shipment and storage.

Door Closures

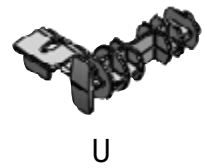

[Scan for video](#)

Door Protection Latch Lock

Part #M27577 fits the 2 3/8" backset & Part #M27578 fits the 2 3/4" backset • latch and lock as one piece.

The latch lock was designed for easy and quick application. The latch lock can easily be applied to an interior and exterior door. This lock helps prevent doors from sagging during transit and keeps the door securely closed all the way up to install.

Door Protection Part #M27583 • Threaded Latch Lock fits 2 3/8" and 2 3/4" backset

Our Threaded Latch lock is a 2-piece door plug and can be used for 2 3/8" and 2 3/4" backset doors with jambs up to 1 1/4" thick, right- or left-hand swing. The design of this product is for easy application. The threaded latch lock can be used for both interior and exterior doors.

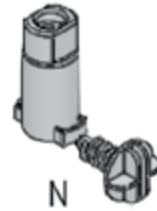

[Scan for video](#)

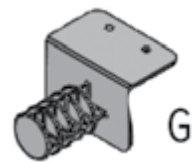

[Scan for video](#)

Metal Door Plug Part #M27666

The metal door plug is used to keep the a prehung metal door securely shut for easily move the door unit and for better shipping.

Door Protection Double Door Clip Part #M27579

The Double Door Clip by MADA is the best way to keep your prehung double doors in place and from sagging prior to install.

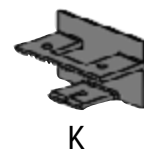

[Scan for video](#)

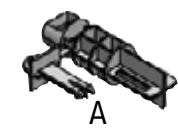

[Scan for video](#)

Sidelight Door Plug Part #M27662

This door plug is used for prehung door units with sidelights. Simply slide the door plug through the bore hole and use the key to lock the door plug in place to keep the door secure.

Door Plug with Spacer Not stocking • call for info

This door clip wraps around the jamb and locks into the plug. No tools are required to apply this door clip. We have added a spacer to this plug to give it a point of contact when the doors are being shipped and in storage. We have both 2 3/8" backset and 2 3/4" backset.



[Scan for video](#)

Door Unit Protection

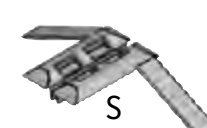

[Scan for video](#)

Skid Plate with Strap Not stocking • call for info

This interior door skid plate is used to keep the bottom of the door moving during shipping. This skid plate is applied by stapling the skid plate to the bottom of the jamb and under the door. By using this skid plate, you will reduce the damage of the bottom of the doors during shipping.

Door Skid Plate Not stocking • call for info

Designed to make the door easier to slide. Available in 4 9/16" jamb size

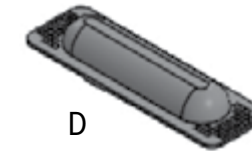

[Scan for video](#)

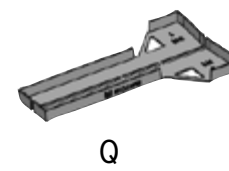

[Scan for video](#)

Door Protection Brickmold Skid Plate 4" Part #M27580

This skid plate was design to protect the jamb and brickmold while making it easy to move the doors. This easy to apply skid plate can be stapled to the bottom of the unit. These skid plates come as pairs, so it will cut down on boxes and running out of either a left or right side skid plate.

Door Protection, Brickmold Skid Plate 6" Part #M27581

This skid plate was design to protect the jamb and brickmold while making it easy to move the doors. This easy to apply skid plate can be stapled to the bottom of the unit. These skid plates come as pairs, so it will cut down on boxes and running out of either a left or right side skid plate.

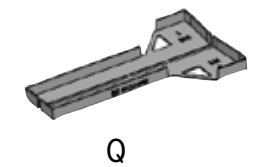

[Scan for video](#)



[Scan for video](#)

Top Spacer Not stocking • call for info

This easy to apply top spacer goes on top of the head jamb to protect the prehung door units during shipping and in storage. The top spacer is a cushion that will absorb the impact of the adjacent doors hitting.

Outer Molding Retainer Clip Part # M27638

This clip is used on interior doors that are shipping one side of the casing loose. After placing the loosing casing on top of the applied casing, attach the easy to apply retainer clip around both casing. This will secure the casing and minimize damage.

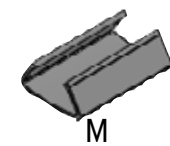

[Scan for video](#)



Scan for video

2BSquare System



Alignment System Top Part #M27584

2BSquare is a 2 piece combination shipping clip and installation assist. Currently in the Millwork Distribution business we experience installation issues on most all exterior doors due to the fact that there is no standard or control over the door once it gets into the field. The door manufacturers send installation instructions with the door panels and the distributors apply them to the door frames and send to the customers. From that point, the doors can get installed any which way the installer chooses (Experienced or not).

The most common way to secure a door and frame for shipping is to use a trap with a screw to the outside of the frame, a duplex nail through the outside of the frame or a plastic twist bore lock. They seem to hold well for shipping but as soon as it gets to the job site to be set into the opening, it has to be removed and the door and frame are loose and shaky when setting into the opening. This causes the door unit to shift while being set and shimmed.



Alignment System Bottom Part #M27585

2BSquare is design to eliminate both of these problems with a simple 2 piece shim/install clip system that ensures the the door panel stays square and plumb all the way through the installation. 2BSquare is basically a T shaped shim system that spaces $\frac{1}{8}$ " margin between the door and the jamb and overlays the inside of the door panel and jamb. It also utilizes a $\frac{3}{8}$ " x $\frac{3}{8}$ " x 1" block on the bottom "T" shim to space the door panel off of the threshold. The design uses a Corner T Shim at the top of the panel and attaches to the frame with small screws or staples. The Bottom T Shim has the block for the threshold spacer mounted on both sides so it must be cut off of one side depending on the handing of the door unit. Once that side is removed, the shim is installed at the bottom of the door unit between the door panel and the jamb, and also between threshold and sweep. It is attached to the frame with a small screw or staples. The shim spacers allow for a $\frac{1}{8}$ " margin to be maintained around the door frame and for the panel and the frame to remain on the same plane while shipping and installing.

Once it arrives on the job site, the shims will stay in place throughout the install. The door is simply put into the opening with all the shims still in place ensuring that the door has a $\frac{1}{8}$ " margin around the frame and the plane of the panel and frame are the same. At this point according to factory instructions, you would level and plumb the door unit, shim and place and nail through the jambs. Unfortunately several doors are not installed this way but by nailing through the brickmold.

If a door is installed by just nailing through the trim, the shims are designed to hold the door unit as true as possible during the install. This helps to ensure that the door unit will operate the way it was designed to with the proper margins around the door panel. Once it is installed, you remove 2BSquare from the frame and operate the door and check it for square and plumb.

This system is simple and designed to help eliminate air and water leaks, opening and closing issues, and headaches for most every door distributor in business today.

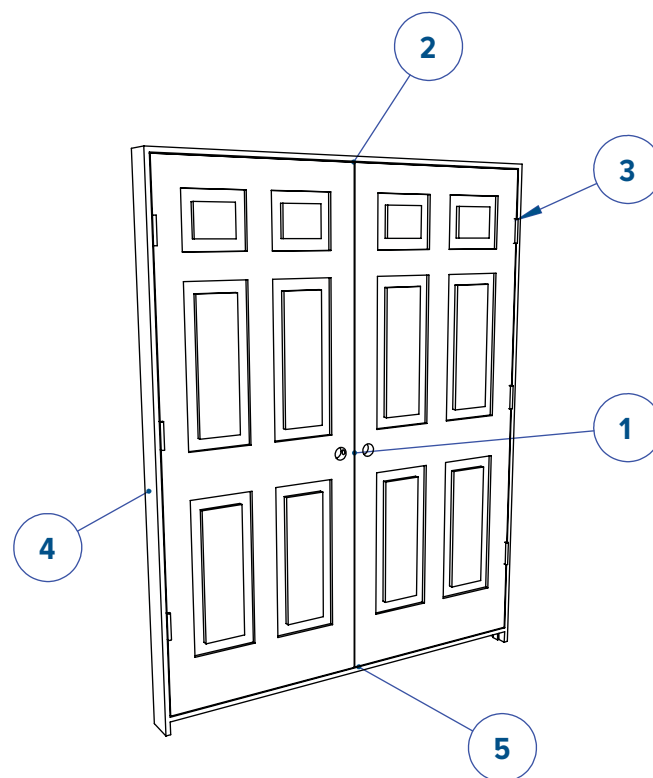
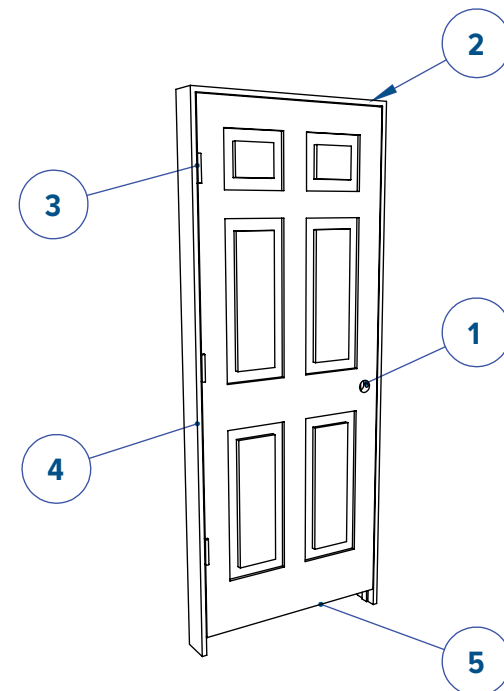

1. Door Closures

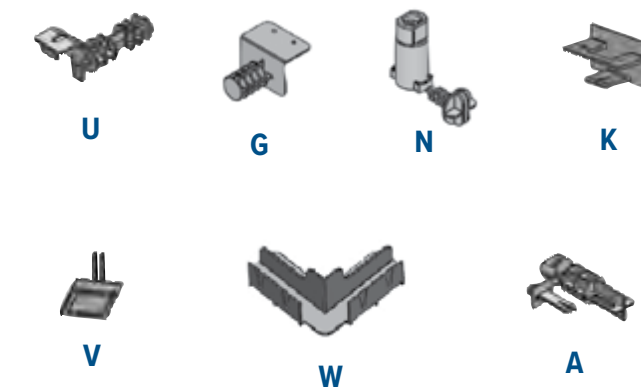

2. Door Unit Protection



3. Hinge Protection

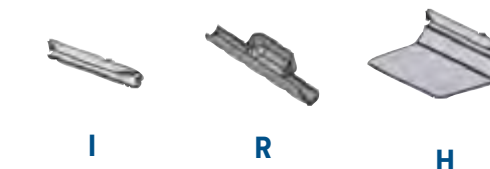

4. Lift Handle



5. Skid Plates

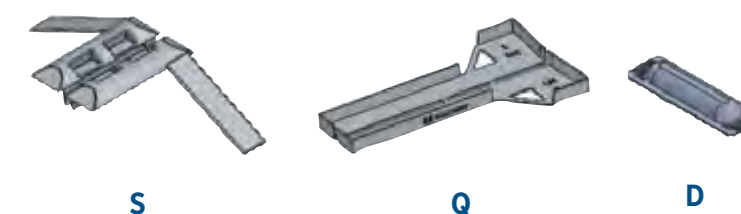



Damage during transportation is always inconvenient; improve durability and solve problems before they happen with Penrod door protection.

Not Penrod products. If you're a distributor or manufacturer, when you order the Penrod Door Protection solutions, you know you're not just getting a high-quality product, you're tapping into an extremely reliable distribution system that protects your finished goods and adds value to your customer's business.

Penrod Door Protection is:

- Available today
- Ships alongside hinges and hardware
- Quality construction
- Supported by great customer service

For more information about Penrod's door protection solutions, ask your dealer or distributor, or call 800.537.3497.

ThePenrodCompany.com